

ARS04 Series

► FEATURES

- Ambient temperature : -40°C~70°C
- Rated current: 10A
- Steel retainer type: ARS-H4
- Module: non-available
- Wire strip length: 7mm
- Applicable relay type: ART/Q、ARK series
- Rated voltage: 250VAC
- Dielectric strength min.: 2000VAC(between input & output)
- Marker: non-available
- Terminal torque : 1.0Nm
- Max. wire range : 2×1.5mm²

► MODEL DESCRIPTION

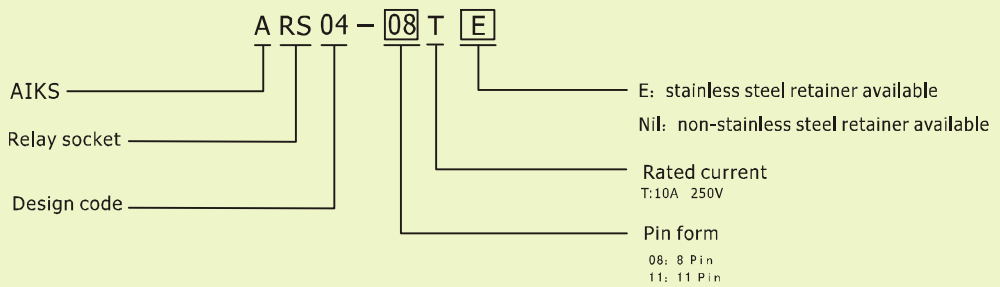

► OUTLINE DIMENSIONS, WIRING DIAGRAM AND PC BOARD LAYOUT

Unit: mm

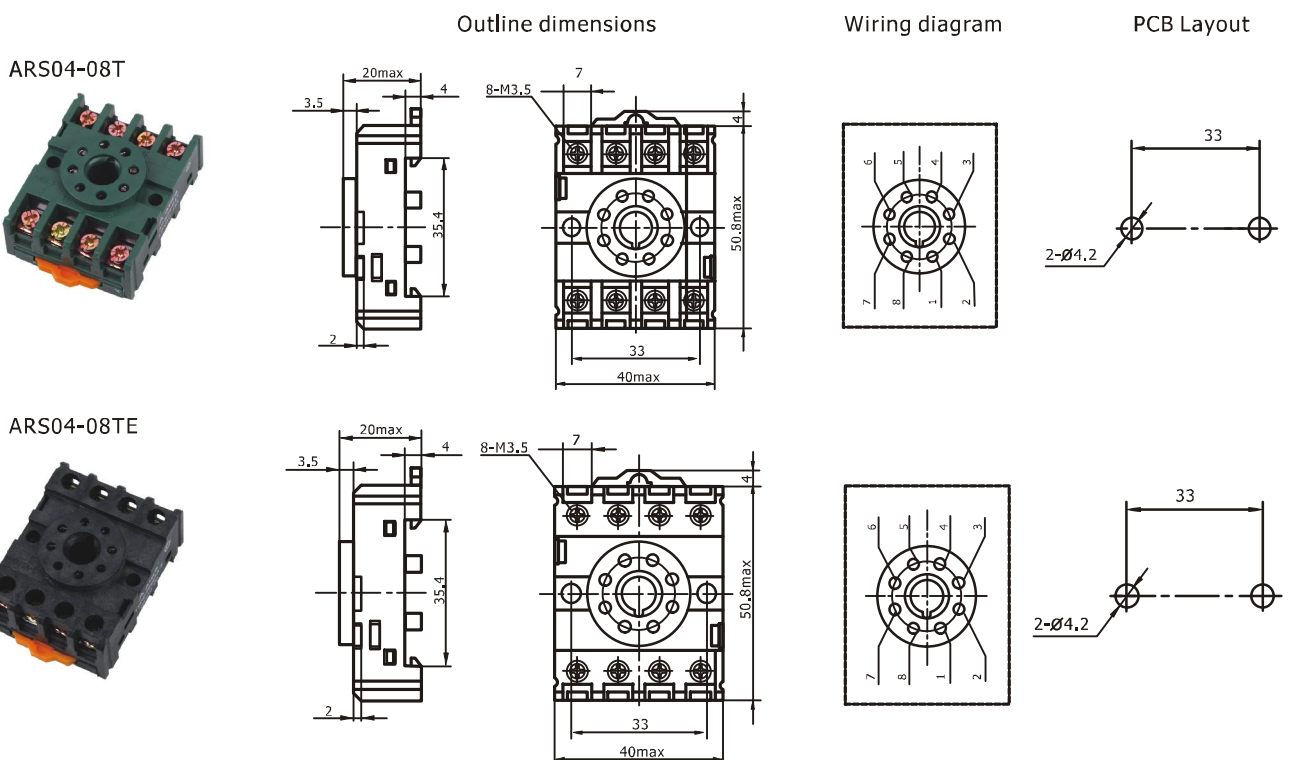

▶ OUTLINE DIMENSIONS, WIRING DIAGRAM AND PC BOARD LAYOUT Unit: mm

Outline dimensions

Wiring diagram

PCB Layout

ARS04-11T

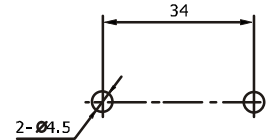
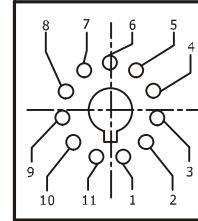
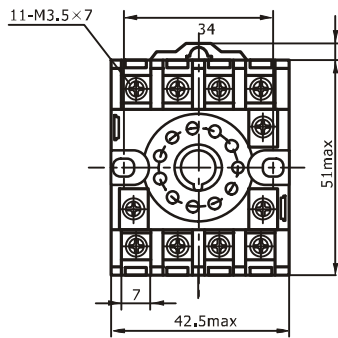
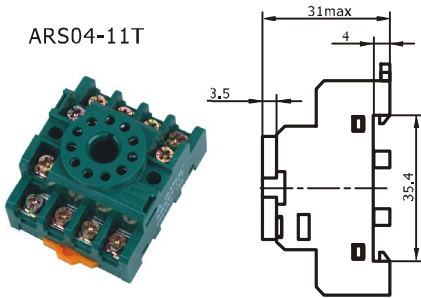

ARS04-14TE

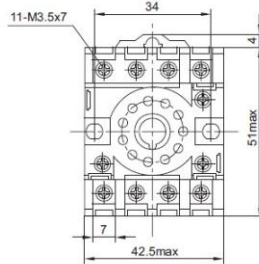
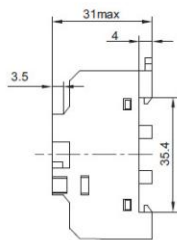

(顶视图)

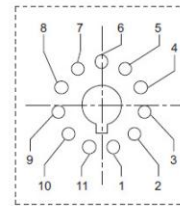

(顶视图)

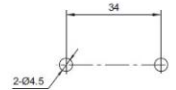

▶ RETAINER DIMENSIONS Unit: mm