

## ARS02 Series

### ► FEATURES

- Ambient temperature : -40°C~70°C
- Rated current: 5A
- Steel retainer type:: ARS-H1
- Module: non-available
- Wire strip length: 7mm
- Applicable relay type: ARL series
- Rated voltage: 250VAC
- Dielectric strength min.: 2000VAC(between input & output)
- Marker: non-available
- Terminal torque : 1.0Nm
- Max. wire range : 2×1,5mm<sup>2</sup>

### ► MODEL DESCRIPTION

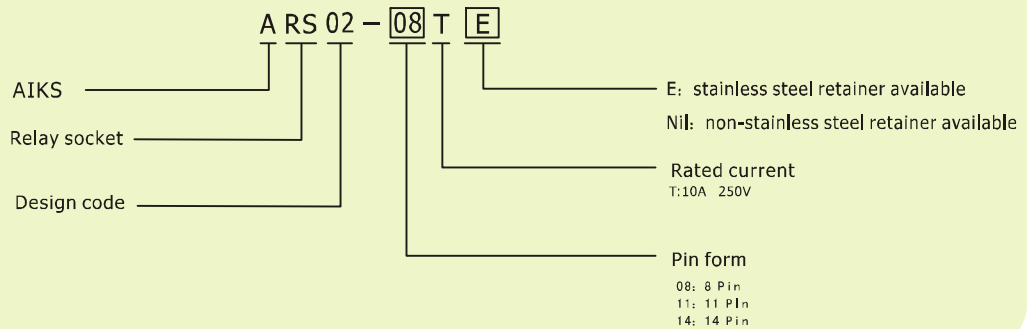

### ► OUTLINE DIMENSIONS, WIRING DIAGRAM AND PC BOARD LAYOUT

Unit: mm

ARS02-08T



Outline dimensions

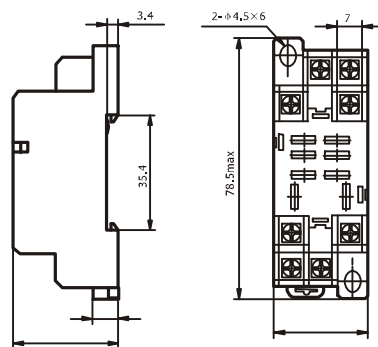

Wiring diagram

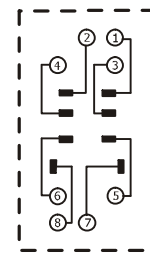

PCB Layout

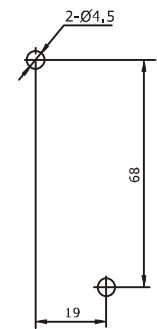

ARS02-08TE

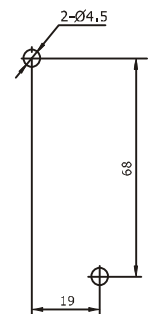
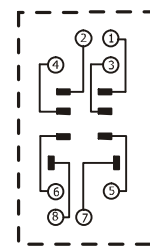
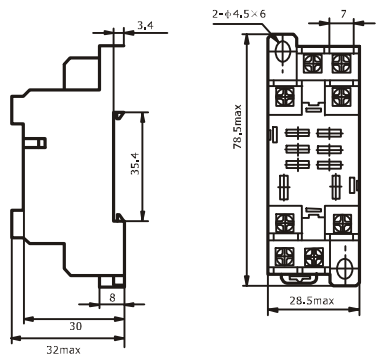

▶ OUTLINE DIMENSIONS, WIRING DIAGRAM AND PC BOARD LAYOUT Unit: mm

ARS02-11T



Outline dimensions

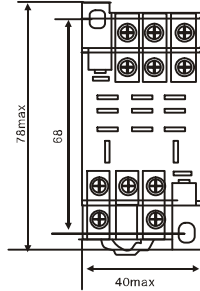
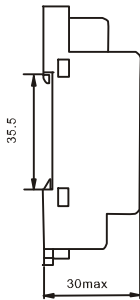

Wiring diagram

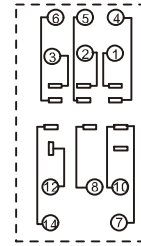

PCB Layout

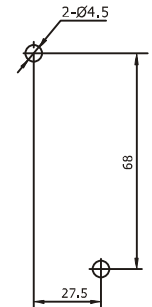

ARS02-14T

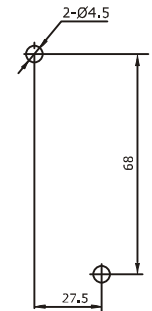
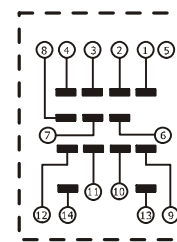
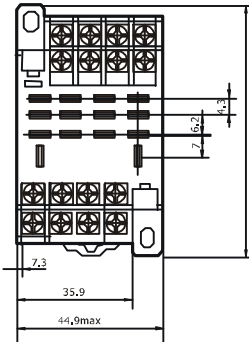
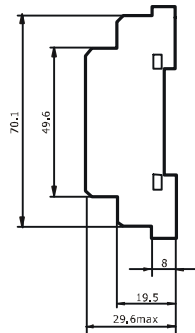

ARS02-14TE

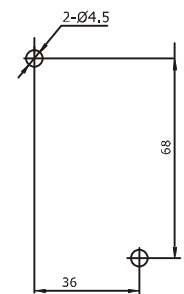
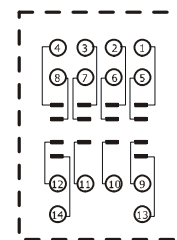
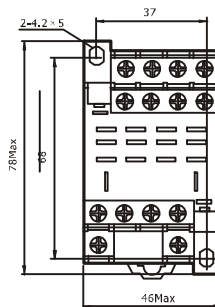
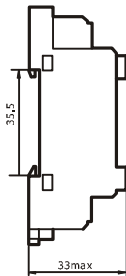

▶ RETAINER DIMENSIONS Unit: mm

ARS-H1

