

## ARS01 series

### ► FEATURES

- Ambient temperature : -40°C~70°C
- Rated current: 5A
- Steel retainer type: ARS-H1
- Module: non-available
- Wire strip length: 7mm
- Applicable relay type: ARM series
- Rated voltage: 250VAC
- Dielectric strength min.: 2000VAC(between input & output)
- Marker: non-available
- Terminal torque : 0.8Nm
- Max. wire range : 2×1.5mm<sup>2</sup>

### ► MODEL DESCRIPTION

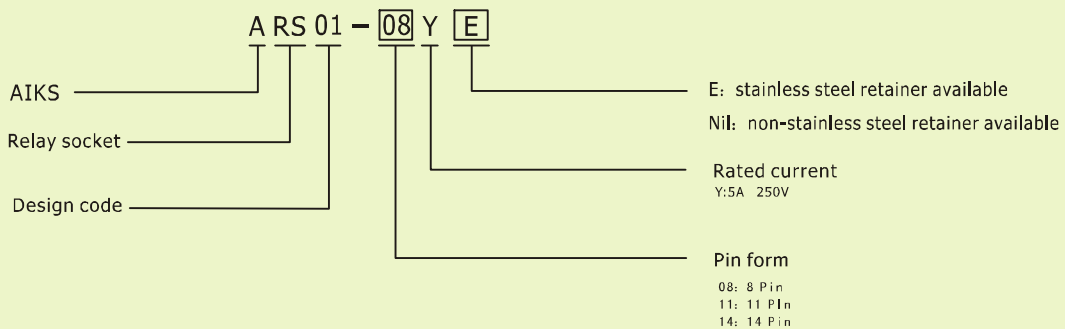

### ► OUTLINE DIMENSIONS, WIRING DIAGRAM AND PCB BOARD LAYOUT

Unit: mm

ARS01-08Y



Outline dimensions

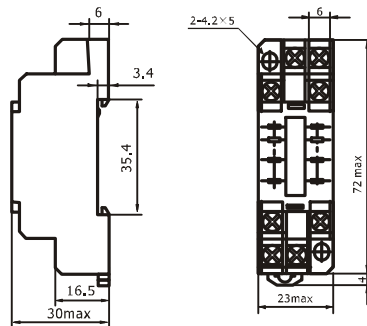

Wiring diagram

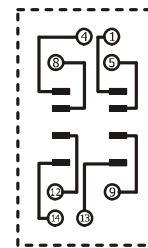

PCB Layout

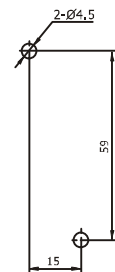

ARS01-08YE

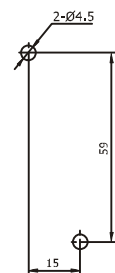
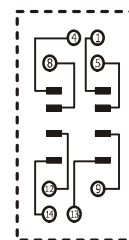
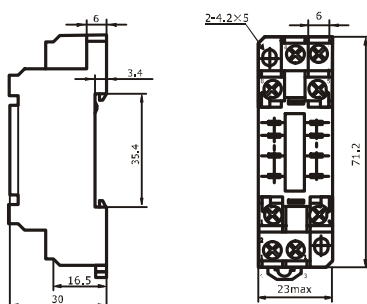

▶ OUTLINE DIMENSIONS, WIRING DIAGRAM AND PCB LAYOUT Unit: mm

ARS01-11Y



Outline dimensions

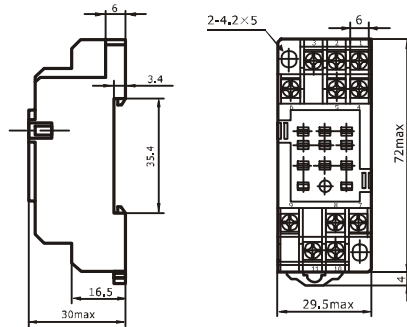

Wiring diagram

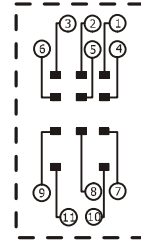

PCB Layout

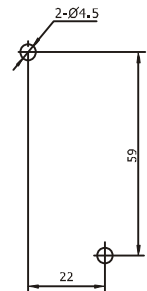

ARS01-11YE

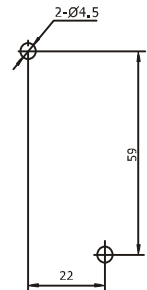
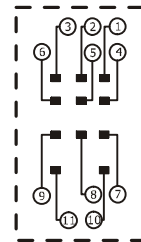
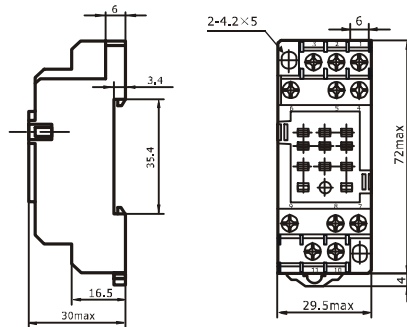

ARS01-14Y

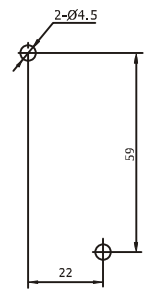
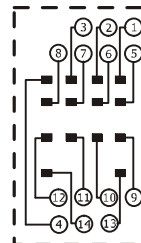
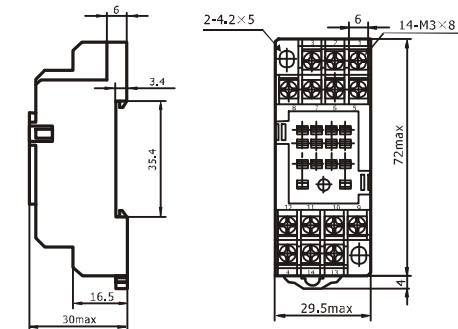

ARS01-14YE

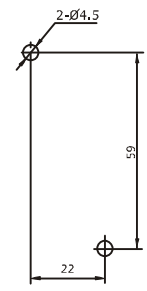
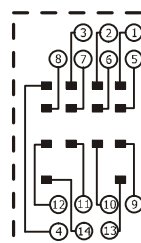
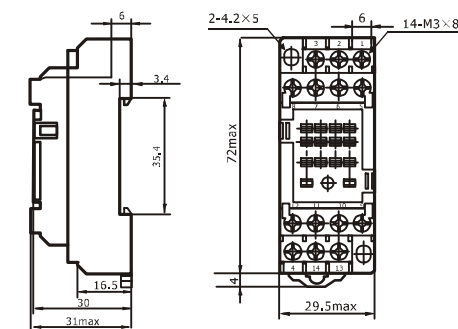

**▶ RETAINER DIMENSIONS**

Unit: mm

ARS-H1

